

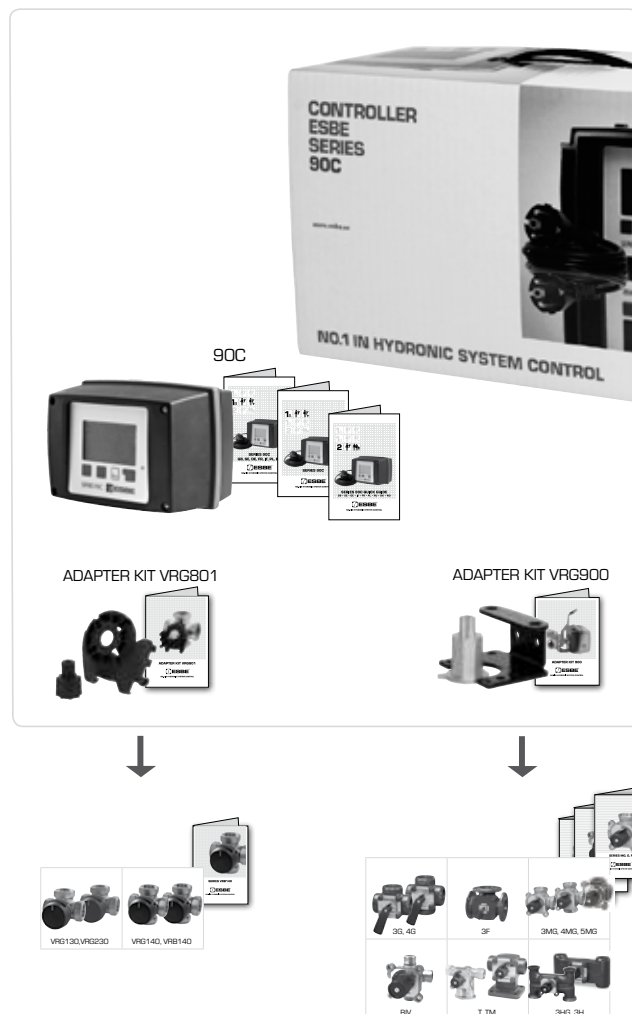

CONTROLLER SERIES 90C



PLEASE READ THESE INSTRUCTIONS IN FULL BEFORE USING THE CONTROLLER.



			INSTRUCTION CONTENTS	PAGE	
			About Controller series 90C	3	
			Safety instructions	3	
			EC Declaration of Conformity	3	
			General instructions	3	
			Explanation of Symbols	3	
			Changes	3	
			Warranty	3	
			Technical data	3	
			Scope of Supply	3	
			Fitting the Actuator	4	
			Installation of temperature sensors	4	
			Installation Power outputs	4	
			Power supply - Electrical Connection	4	
			Set-Up	4	
			Commissioning help / Set-Up Wizard	4	
			Free commissioning	4	
			Mal Functions / Maintenance	4	
			Mal functions with error messages	4	
			Maintenance	4	
			Useful Notes / Tips & Tricks	5	
			Menu Navigation	5	
			Display and Input	5	
			Menu Sequence	5	
			Menu Structure	5	
AVAILABLE IN VERSION			MENU		
90C-1	90C-2	90C-3	1	Measurement	6
90C-1	90C-2	90C-3	2	Statistics	6
90C-1	90C-2	90C-3	3	Operating Times	6
90C-1	90C-2	90C-3	4	Operating Modes	6
90C-1	90C-2	90C-3	5	Setting Heating Circuit	7
				Curve Examples	7
-	90C-2	90C-3	6	Heating Circuit 2 settings	7
-	90C-2	90C-3	7	DHW Settings	7
-	-	90C-3	8	Energy transfer	8
-	-	90C-3	9	Solar	8
-	-	90C-3	10	Load Pump	8
90C-1	90C-2	90C-3	14	Protections	8
90C-1	90C-2	90C-3	15	Special Functions	8
90C-1	90C-2	90C-3	16	Menu Lock	9
90C-1	90C-2	90C-3	17	Service Data	9
90C-1	90C-2	90C-3	18	Language	9
			Room Sensor	9	
			Hydronic variants - Application details	10-12	
			Hydronic variants - Application examples	13-14	

CONTROLLER SERIES 90C

ABOUT THE CONTROLLER

The weather compensated integrated Heating Controller Series 90C facilitates efficient use and function control of your heating system. The device is impressive most of all for its functionality and simple, almost self-explanatory operation. For each step in the input process the individual entry keys are assigned to appropriate functions and explained. The controller menu contains headwords for the measured values and settings, as well as help texts or clearly-structured graphics.

Important characteristics of the series 90C:

- Depiction of graphics and texts in a lighted display
- Simple viewing of the current measurement values
- Statistics and monitoring of the system by means of statistical graphics, etc.
- Extensive setting menus with explanations
- Menu block can be activated to prevent unintentional setting changes
- Resetting to previously selected values or factory settings
- Automatic full calibration of valve positions at least once a day **and after a power failure or disruption**.
- Mixer valve operation range could be altered 90°/180° or 270°

DISPOSAL AND POLLUTANTS

The unit conforms to the European RoHS directive 2002/95/EC for the restriction of the use of certain hazardous substances in electrical and electronic equipment.



The device must not be disposed of together with domestic waste. This applies in particular to the printed circuit card. Legislation may demand special handling of certain components, or it may be desirable from an ecological point of view. Local and currently valid legislation must be observed.

SAFETY INSTRUCTIONS

EC DECLARATION OF CONFORMITY

By affixing the CE mark to the unit the manufacturer declares that the series 90C conforms to the following relevant safety regulations:

- CE EC low voltage directive LVD 2006/95/EC
- CE EC electromagnetic compatibility directive EMC 2004/108/EC

Conformity has been verified and the corresponding documentation and the EC declaration of conformity are kept on file by the manufacturer.

GENERAL INSTRUCTIONS

It is essential that you read this!

These installation and operating instructions contain basic instructions and important information regarding safety, installation, commissioning, maintenance and the optimal use of the unit. Therefore these instructions must be read completely and understood by the installation technician/specialist and by the system user before installation, commissioning and operation of the unit.

The valid accident prevention regulations, the regulations of the local power utility, the applicable ISO-EN standards and the installation and operating instruction of the additional system components must also be observed. The controller does not under any circumstances replace any safety devices to be provided by the customer!

Installation, electrical connection, commissioning and maintenance of the unit may only be carried out by specialists who possess the appropriate training.

For the user: Make sure that the specialist gives you detailed information on the function and operation of the controller. Always keep these instructions in the vicinity of the controller.

EXPLANATION OF SYMBOLS

- DANGER** Failure to observe these instructions can result in danger to life from electric voltage.
- CAUTION** Failure to observe these instructions can result in destruction of the unit or the system, or damage to the environment.
- ATTENTION** Information which is especially important for the function and optimal use of the unit and the system.

CHANGES TO THE UNIT

- Changes to the unit can compromise the safety and function of the unit or the entire system.
- Changes, additions to or conversion of the unit are not permitted without written permission from the manufacturer
- It is likewise forbidden to install additional components that have not been tested together with the unit
- If it becomes clear that safe operation of the unit is no longer possible, for example because of damage to the housing, then turn the controller off immediately
- Any parts of the unit or accessories that are not in perfect condition must be exchanged immediately
- Use only original spare parts and accessories from the manufacturer.
- Markings made on the unit at the factory must not be altered, removed or made illegible
- Only the settings actually described in these instructions may be made on the controller
- If the plastic cover on the controller is opened the warranty expires unconditionally

WARRANTY AND LIABILITY

The controller has been manufactured and tested with regard to high quality and safety requirements. The unit is subject to the statutory guarantee period of two years from the date of sale. If the plastic cover on the controller is opened the warranty expires unconditionally.

The warranty and liability shall not include, however, any injury to persons or material damage that is attributable to one or more of the following causes:

- Failure to observe these installation and operating instructions
- Improper installation, commissioning, maintenance and operation
- Improperly executed repairs
- Unauthorised structural changes to the unit

- Installation of additional components that have not been tested together with the unit
- Any damage resulting from continued use of the unit despite an obvious defect
- Failure to use original spare parts and accessories
- Use of the device for other than its intended purpose
- Operation above or below the limit values listed in the specifications

TECHNICAL DATA, SERIES 90C

zBasic unit: _____ Actuator controller with plastic housing, prewired for supply and sensors
 Dimensions (HxWxT): _____ approx. 95x135x85 mm
 Display: _____ fully graphical display 128x64 dots
 Light emitting diode: _____ polychrome / multicolour
 Operation: _____ input keys

Power supply: _____ 230 ± 10% V AC, 50/60 Hz
 Power consumption: _____ ca 5.0 VA
Total switching capacity of the relay outputs 1-3:2 (0,8) A 250 VAC (Circulation pump 185V)
 Enclosure rating: _____ IP 54 as per DIN 40050 CE
 Protection class: _____ II

Ambient temperature: _____ 0° to 40°C max.
 Ambient atmospheric humidity: _____ max. 85% RH at 25°C

Actuator: _____ Running time 120 s/90°
 Torque: _____ 15 Nm
 Mixer valve operation range: _____ 90 / 180 or 270°
 Sensors: _____ Temperature sensor type PT1000
 Sensor cable: _____ 4x0.38mm², max. length 30m
 Temperature range: Flow pipe sensor CRS211 _____ 0 to +105°C
 Outdoor sensor CRS214 _____ -50 to +70°C
 Universal sensor CRS213 _____ 0 to +105°C
 Room sensor CRS231 _____ +10 to +30°C
 High temperature sensor CRS215 _____ -50 to +550°C
 Weight: _____ 0.9 kg

Temperature resistance table for Pt1000 sensors:

T./°C	0	10	20	30	40	50	60	70	80	90	100
R./Ω	1000	1039	1077	1116	1155	1194	1232	1270	1308	1347	1385

SCOPE OF SUPPLY

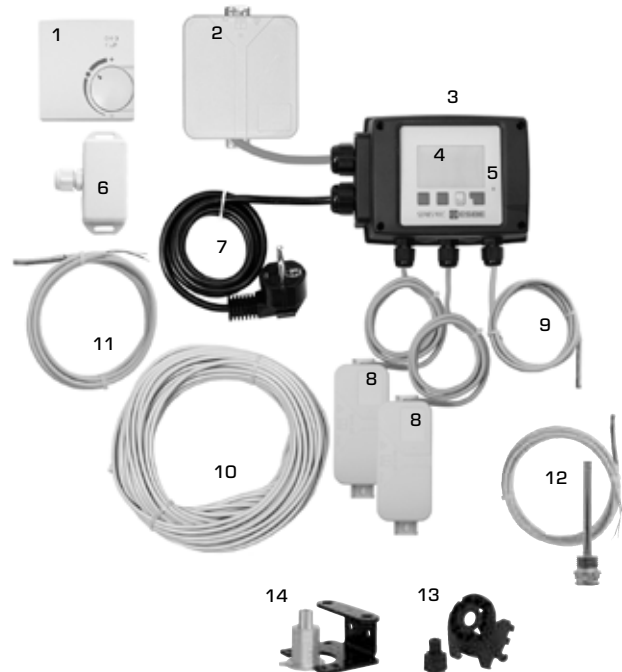

1. Optional room sensor can be connected
 2. Power output box is prewired*
 3. Functional test by means of status display with LED
 4. 128x64 dot fully graphical display
 5. Self-explanatory operation using softkey buttons
 6. Outdoor sensor
 7. 1.5 m power supply cable with plug is ready for connection
 8. Sensor boxes are prewired*
 9. Flow pipe sensor with 1.5 m cable is prewired
 10. 20 m cable for sensors is optional
 11. Universalsensor - Ø5mm, 1,5m*
 12. Optional high temperature sensor can be connected
 13. Adaptor kit ESBE valves VRG, VRB
 14. Adaptor kit ESBE valves MG, G, 3F, BIV, 3H, 3HG
- * Depending on version.

FITTING THE ACTUATOR CONTROL



The adaptor kits needed for ESBE mixing valves are supplied with the controller. Connect up the actuator controller and mixing valve as set out in the brief description provided with each adaptor kit.

The controller can also be used for other makes of mixing valve using various adaptor kits that can be ordered. Installation instructions will be enclosed with the adaptor kit.

INSTALLATION OF TEMPERATURE SENSORS



If desired the sensor cables can be extended to a maximum of 30m using a cable with a cross-section of at least 0.38mm². Make sure that there is no contact resistance!

Position the sensor precisely in the area to be measured! Only use immersion, pipe-mounted or flat-mounted sensor suitable for the specific area of application with the appropriate permissible temperature range.



The temperature sensor cables must be routed separately from mains voltage cables, and must not, for example, be routed in the same cable duct!

FLOW PIPE SENSOR CRS211:

The sensor is prewired, and should be secured in a suitable position on the heating circuit's flow pipe using the pipe clip provided. To make sure that the correct temperature is registered, the sensor should be surrounded with pipe insulation.

OUTDOOR SENSOR CRS214:

Mount the outdoor sensor in a shady position out of the wind on the north side of the building.

Connect the cable in the sensor box – polarity does not matter in this case. Depending on the inertia of the heating system, set the back of the sensor box into the brickwork if necessary in order to take the residual heat of the building into account.

ROOM SENSOR CRS231:

If a room sensor is required, it should be connected as follows: Strip a maximum of 40 mm of insulation from a 4x0.38 mm² cable and insert the end of the cable through the free lead-in on the underside of the actuator cover. Connect the cable to the two free terminals in the black cover – polarity does not matter in this case.

UNIVERSAL SENSOR CRS213

Mount and secure the sensor in a suitable position according to the application. To make sure the correct temperature is registered, the sensor should be surrounded with pipe insulation.

HIGH TEMPERATURE SENSOR CRS215:

Install the immersion sensor pocket in a suitable place for the application. Mount the high temperature sensor inside the immersion sensor pocket.

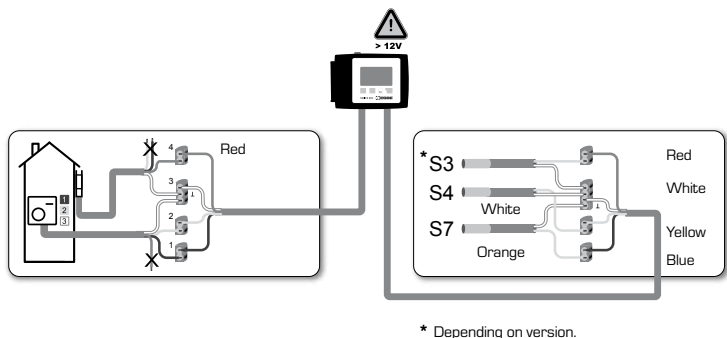

INSTALLATION POWER OUTPUTS



Safety information: Power supply must be switched off completely before work is started on the control and connected loads.
Warning: 230 VAC

If the circulation pump is to be operated via the controller, remove the three safety terminals from the preconnected cable and connect the cable to the circulation pump as follows:

Green/yellow: Earth PE
Blue: Neutral N
Brown/black/grey: Phase L

Please note: If the pump is not connected, the electrician should remove the cable.

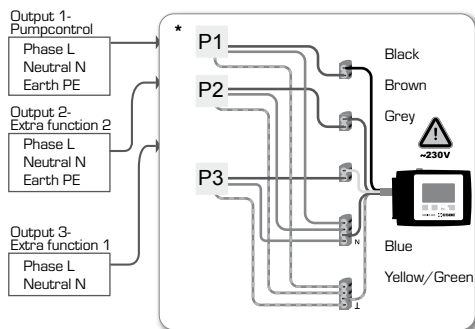

* Depending on version.

POWER SUPPLY - ELECTRICAL CONNECTION



Safety information: Power supply must be switched off completely before work is started on the control and connected loads.
Warning: 230 VAC

Please note: The controller replaces in no way safety devices. Precautions such as frost, scald and overpressure protection, etc., must be provided in the installation if necessary.

The controller must only be installed by a qualified electrician in accordance with standards and/or local regulations.

The 90C controller should be wired up in the following order:

Plug the preconnected cable labelled "power supply" into a 230 V / 50 Hz socket outlet with earthing contact.

Wiring:
Green/yellow: Earth PE
Blue: Neutral N
Brown: Phase L

SET-UP

COMMISSIONING HELP / SET-UP WIZARD

The first time the controller is turned on and after the language and time are set, a query appears as to whether you want to parametrise the controller using the commissioning help or not. The commissioning help can also be terminated or called up again at any time in the special functions menu 15.2. The commissioning help guides you through the necessary basic settings in the correct order, and provides brief descriptions of each parameter in the display.

Pressing the „esc“ key takes you back to the previous value so you can look at the selected setting again or adjust it if desired. Pressing the „esc“ more than once takes you back step by step to the selection mode, thus cancelling the commissioning help.



Observe the explanations for the the individual parameters on the following pages, and check whether further settings are necessary for your application.

FREE COMMISSIONING

If you decide not to use the commissioning help, you should make the necessary settings in the following sequence:

- Menu 18. Language
- Menu 3. Time, date and operating times
- Menu 5. Settings for heat circuit, all settings
- Menu 14. Protective functions if necessary
- Menu 15. Special functions if necessary
- Menu 4.2. Operating mode „Manual“ should be used to test the switch outputs with the consumers connected, and to check the sensor values for plausibility. Then switch on automatic mode.



Observe the explanations for the the individual parameters on the following pages, and check whether further settings are necessary for your application.

MALFUNCTIONS / MAINTENANCE



Do not open the unit until it has been disconnected!

MALFUNCTIONS WITH ERROR MESSAGES

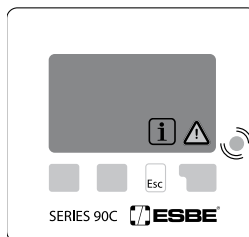

If the controller detects a malfunction, the red light flashes and the warning symbol also appears in the display. If the error is no longer present, the warning symbol changes to an info symbol and the red light no longer flashes. To obtain more detailed information on the error, press the key under the warning or info symbol.



Do not try to deal with this yourself. Consult a specialist in the event of an error!

Possible error/information messages:

Sensor x defective >

Notes for the specialist:

Means that either the sensor, the sensor input at the controller or the connecting cable is/was defective. (Resistance table on page 3)

max. heat circuit (Information only) >

The maximum heat circuit temperature set in menu 5.4 was exceeded.

Restart (Information only) >

Means that the controller was restarted, for example due to a power failure. Check the date&time!

MAINTENANCE



In the course of the general annual maintenance of your heating system you should also have the functions of the controller checked by a specialist and have the settings optimised if necessary.

Performing maintenance:

- Check the date and time (see menu 3.1)
- Assess/check plausibility of statistics (see menu 2)
- Check the error memory (see menu 2.6)
- Verify/check plausibility of the current measurement values (see menu 1)
- Check the switch outputs/consumers in manual mode (see menu 4.2)
- Poss. optimise the parameter settings

USEFUL NOTES / TIPS AND TRICKS



- The service values (see menu 17) include not only current measurement values and operating states, but also all of the settings for the controller. Write the service values down just once after commissioning has been successfully completed.

- In the event of uncertainty as to the control response or malfunctions the service values are a proven and successful method for remote diagnosis. Write the service values down (see menu 17) at the time that the suspected malfunction occurs. Send the service value table by fax or e-mail with a brief description of the error to the specialist or manufacturer.

- To protect against loss of data, record any statistics and data that are particularly important to you (see menu 2) at regular intervals.

MENU NAVIGATION - SETTING AND CHECKING PARAMETERS

DISPLAY AND INPUT

The display (1), with its extensive text and graphics in overview mode, is almost self-explanatory, allowing easy operation of the controller.

The LED (2) lights up green when a relay is switched on.

The LED (2) lights up red when operating mode „Off“ is set.

The LED (2) flashes slowly red in the operating mode „Manual“.

The LED (2) flashes quickly red when an error is present.

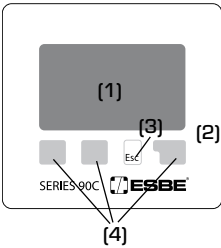

Entries are made using four keys (3+4), to which different functions are assigned depending on the situation. The „esc“ key (3) is used to cancel an entry or to exit a menu. If applicable there will be a request for confirmation as to whether the changes which have been made should be saved.

The function of each of the other three keys (4) is shown in the display line directly above the keys; the right-hand key generally has a confirmation and selection function.

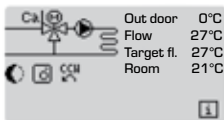

MENU SEQUENCE

The overview mode appears when no key has been pressed for 2 minutes, or when the main menu is exited by pressing „esc“.

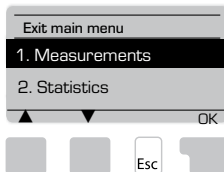

The menu is closed by pressing "esc" or selecting "Exit measurements".

Pressing a key in graphics or overview mode takes you directly to the main menu. The following menu items are then available for selection there.

Examples of display symbols:

- Heating circuit pump (rotates when active)
- Heating circuit mixer (black when active)
- Day mode (Time progr.)
- Night mode (Time progr.)
- Comfort mode (Time progr.)
- Day mode
- Night mode
- Day mode due to Room sensor
- Night mode due to Room sensor
- Heat activated (Info only)
- Domestic hot water activated (Info only)
- Reference value mode
- Reference value 14 day
- Warning / Error message
- New information available

Examples of key functions:

- +/- = enlarge/shrink values
- ▼/▲ = scroll menu down/up
- yes/no = approve/reject
- Info = additional information
- Back = to previous screen
- ok = confirm selection
- Confirm = confirm setting

MENU STRUCTURE

MENU AVAILABLE IN version

90C- 1 2 3

1. Measurement

- 1.1 Outdoor
- 1.2 Flow
- 1.3 Flow 2
- 1.4 Sensor 4
- 1.5 Room
- 1.6 Room sensor
- 1.7 RC switch
- 1.8 Target flow
- 1.9 Target flow 2

90C- 1 2 3

2. Statistics

- 2.1 Today
- 2.2 28 days
- 2.3 Outdoor 8760h
- 2.4 Flow 8760h
- 2.5 Op.hours HC
- 2.6 Op.hours DHW
- 2.7 Op.hours HC2
- 2.8 Op.hours Heat
- 2.9 Error messages
- 2.10 Reset/Clear

90C- 1 2 3

3. Times

- 3.1 Time and date
- 3.2 Daylight Saving
- 3.3 Heating circuit day
- 3.4 Heating comfort
- 3.5 Hot water enable
- 3.6 Hot water AL

90C- 1 2 3

4. Operating mode

- 4.1 Heating circ.
- 4.2 Manual
- 4.3 Heat circuit reference
- 4.4 14 day reference
- 4.5 Domestic hot water

90C- 1 2 3

5. HC Settings

- 5.1 S/W day
- 5.2 S/W night
- 5.3 Curve
- 5.4 Day correct
- 5.5 Night correct
- 5.6 Comfort temp. boost
- 5.7 Reference/actual -
- 5.8 Reference/actual +

90C- - 2 3

6. HC 2 Settings

- 6.1 S/W day
- 6.2 S/W night
- 6.3 Curve
- 6.4 Day correct
- 6.5 Night correct
- 6.6 Comfort temp. boost

90C- - 2 3

7. DHW Settings

- 7.1 Hotwater min.
- 7.2 DHW target
- 7.3 DHW hysteresis

90C- - - 3

8. Energy transfer

- 8.1 Pump start temp.
- 8.2 Hysteresis
- 8.3 Target temp.

90C- - - 3

9. Solar

- 9.1 Hysteresis
- 9.2 Pump stop temp.

90C- - - 3

10. Load pump

- 10.1 Pump start temp
- 10.2 Hysteresis
- 10.3 Min. running time

90C- 1 2 3

14. Protections

- 14.1 Frost protection
- 14.2 Min. flow
- 14.3 Max. flow
- 14.4 Max flow 2
- 14.5 Anti-legionella

90C- 1 2 3

15. Special functions

- 15.1 Sensor calibration
- 15.2 Commissioning
- 15.3 Factory settings
- 15.4 Expansions (n/a)
- 15.5 Mixer
- 15.6 Room sensor
- 15.7 System

90C- 1 2 3

16. Menu Lock

- 16.1 Menu Lock

90C- 1 2 3

17. Service Data

90C- 1 2 3

18. Language

- 2.3.1 Current Year
- 2.3.2 Previous Year
- 2.3.3 2 years ago
- 2.4.1 Current Year
- 2.4.2 Previous Year
- 2.4.3 2 years ago
- 2.5.1 Op.hours HC
- 2.5.2 Since
- 2.6.1 Op.hours DHW
- 2.6.2 Since
- 2.7.1 Op.hours HC 2
- 2.7.2 Since
- 2.8.1 Op.hours HC heat
- 2.8.2 Since
- 2.10.1 Today
- 2.10.2 28 days
- 2.10.3 Outdoor 8760h
- 2.10.4 Flow 8760h
- 2.10.5 Operating Hours
- 2.10.6 Error messages
- 2.10.7 All statistics

- 15.1.1 Outdoor
- 15.1.2 Flow
- 15.1.3 Domestic hot water
- 15.1.4 Sensor 4
- 15.1.5 Room
- 15.1.6 Room sensor
- 15.5.1 Valve type
- 15.5.2 Min angle
- 15.5.3 Max angle
- 15.5.4 Direction
- 15.5.5 Turn time
- 15.5.6 Pause factor
- 15.5.7 Increase
- 15.5.8 Calibration
- 15.6.1 Room sensor
- 15.6.2 Room ref. day
- 15.6.3 Room ref. night
- 15.7.1 Extra function 1
- 15.7.2 Extra function 2
- 15.7.3 Valve position
- 15.7.4 Heat delay
- 15.7.5 Valve delay

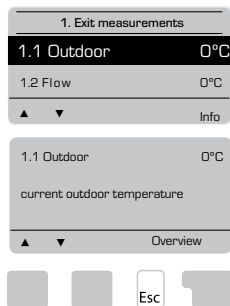

Current temperature values with explanations.

"Measurements" serves to display the currently measured temperatures. The submenus described under 1.1-1.9 are available. The menu is closed by pressing "esc" or selecting "Exit measurements".

Selecting "Info" leads to a brief help text explaining the measurement values.

Selecting "Overview" or "esc" exits the Info mode.

! If "Error" appears on the display instead of the measurement value, then there may be a defective or incorrect temperature sensor:

What measurement values are displayed depends on the selected program, the connected sensors and the specific device design.

- 1.1 OUTDOOR
- 1.2 FLOW
- 1.3 FLOW 2
- 1.4 SENSOR 4
- 1.5 ROOM
- 1.6 ROOM SENSOR
- 1.7 RC SWITCH
- 1.8 TARGET FLOW
- 1.9 TARGET FLOW 2

If the cables are too long or the sensors are not placed optimally, the result may be small deviations in the measurement values. In this case the display values can be compensated for by making entries on the controller. Follow the instructions under menu 15.1

Function control of the system with operating hours, etc.

For system data statistics it is essential for the time to be set accurately on the controller. Please note that the clock continues to run for about 24 hours if the mains voltage is interrupted, and after that has to be reset. Improper operation or an incorrect time may result in data being cleared, recorded incorrectly or overwritten.

! The manufacturer accepts no liability for the recorded data!

2.1 TODAY (=FLOW TEMPERATURE DURING THE LAST 24 HOURS)

In the graphical overview the characteristics of outdoor-and flow temperature during the last 24 hours is shown. The right button changes the unit of time and the two left buttons scroll through the diagram.

2.2 28-DAYS (=FLOW TEMPERATURE DURING THE LAST 28 DAYS)

In the graphical overview the characteristics of the outdoor and flow temperature during the last 28 days is shown. The right button changes the unit of time (Days) and the two left buttons scroll through the diagram.

2.3 OUTDOOR 8760H (1YEAR)

- Menu 2.3.1 Current year
- Menu 2.3.2 Previous year
- Menu 2.3.3 2 years ago

xh: °C hours. Nr of heating hours when heating is required, ie hours with lower outdoor temp than specified.
xd: °C days. Nr of heating days when heating is required, ie days with lower outdoor temp than specified.

2.4 FLOW 8760H (1YEAR)

- Menu 2.4.1 Current year
- Menu 2.4.2 Previous year
- Menu 2.4.3 2 years ago

xh: Nr of hours with flow temp higher than specified.
xd: Nr of days with flow temp higher than specified.

2.5 OPERATING HOURS HEAT CIRCUIT

- Menu 2.5.1 Display of operating hours of the circulation pump/aux. heat.
- Menu 2.5.2 The date the measurement started.

2.6 OPERATING HOURS DHW

- Menu 2.6.1 Display of operating hours of the DHW
- Menu 2.6.1 The date the measurement started

2.7 OPERATING HOURS HEAT CIRCUIT 2

- Menu 2.7.1 Display of operating hours of the circulation pump
- Menu 2.7.2 The date the measurement started.

2.8 OPERATING HOURS HEAT

- Menu 2.8.1 Display of operating hours of the aux. heat.
- Menu 2.8.1 The date the measurement started

2.9 ERROR MESSAGES

Display of the last three errors in the system with indication of date and time.

2.10 RESET/CLEAR

Resetting and clearing the individual statistics. Selecting " All statistics clears everything except for the error log.

Operating times for heating circuit and hot water setting the clock.

! The associated temperature reference values are specified in menu 5 "Settings"!

MENU 3.1 TIME AND DATE

This menu is used to set the current time and date.

For proper functioning of the controller and statistics for the system data it is essential for the time to be set accurately on the controller. Please note that the clock continues to run for about 24 hours if the mains voltage is interrupted, and after that has to be reset.

MENU 3.2 DAYLIGHT SAVING

Automatically adjust clock for daylight savings time.

MENU 3.3 HEATING CIRCUIT DAY

This menu is used to select the daytime mode times for the heating circuit; three time periods can be specified for each weekday and copied over to the following days.

Setting range: Three time ranges for each day of the week

Default: Mo-Su 6:00-22:00

Note: See menu 5.6 for the associated temperature settings

Times that are not specified are automatically considered to be nighttime mode. The set times are only taken into account in the heating circuit operating mode "Automatic".

Ex:

3.2.1. Mo	0	6	12	18	24	3.2.1. Tue	0	6	12	18	24
3.2.1. We	0	6	12	18	24	3.2.1. Th	0	6	12	18	24
3.2.1. Fr	0	6	12	18	24	3.2.1. Sa	0	6	12	18	24
3.2.1. Su	0	6	12	18	24						

MENU 3.4 HEATING COMFORT

This menu can be used to select a time range for each day of the week in which the heating circuit is supplied with an increased comfort temperature, e.g. for quick heating in the morning.

Setting range: One time range for each day of the week

Default: Mo-Su off

Note: See menu 5.5. for the associated temperature settings.

Ex:

3.3.1. Mo	0	6	12	18	24	3.3.1. Tue	0	6	12	18	24
3.3.1. We	0	6	12	18	24	3.3.1. Th	0	6	12	18	24
3.3.1. Fr	0	6	12	18	24						

MENU 3.5 HOT WATER ENABLE

This Menu is activated when Dom. Hot water is selected in menu 15.7.2 It can be used to select the daytime mode times for the domestic hot water; three time periods can be specified for each weekday and copied over to the following days.

Setting range: Three time ranges for each day of the week

Default: Mo-Su 6:00-22:00

Note: See menu 5.4 for the associated temperature settings

MENU 3.6 HOT WATER ANTI-LEGIONELLA

This Menu is activated when Dom. Hot water is selected in menu 15.7.2 It can be used to select a time range for each day of the week

Setting range: One time range for each day of the week

Default: Mo-Su off

Note: See menu 5.5. for the associated temperature settings.

Operating times for heating circuit and hot water; manual mode

! After an interruption of the mains voltage the controller automatically returns to the last operating mode selected!

The controller works with the set operating times and the corresponding different reference flow temperature values only in the automatic mode.

MENU 4.1 HEAT CIRCUIT

Auto = Automatic/Normal mode using the set times.

Continuous Day = The set values for day mode are used.

Continuous Night = The set values for night mode are used.

Reference Value = Fixed flow temperature regardless of the outdoor temperature. The desired flow temperature has to be set in menu 4.3.

14 day reference value = Specific fixed flow temperatures can be set for the next 14 days in menu 4.4. After 14 days, the reference temperature of the 14th day is used until the operating mode is changed.

Off = Heating circuit is switched off (except Frost protection)

Settings range: Auto, Continuous day, Continuous night, Reference value, 14 day reference, Off / Default: Automatic

MENU 4.2 MANUAL

In Manual mode the individual relay outputs and the connected consumers can be checked for proper functioning and correct assignment.

! The operating mode "Manual" may only be used by specialists for brief function tests, e.g. during commissioning!

Function in manual mode:

The relays and thus the connected consumer are switched on and off by pressing a key, with no regard to the current temperatures and the parameters which have been set. At the same time, the current measurement values of temperature sensors are also shown in the display for the purposes of function control.

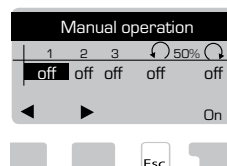

MENU 4.3 HEAT CIRCUIT REFERENCE

If operating mode "Reference value" is selected, (Menu 4.1), the reference flow temperature has to be set here, regardless of the curve/outdoor temperature.

Settings range: 10 °C to 75 °C, Default: 30 °C

MENU 4.4 14 DAY REFERENCE

If operating mode "14 day reference value" is selected (Menu 4.1), the reference flow temperature for each of the 14 days can be set here.

In the first menu 4.4.1 the starting time of the program is shown. To start the program, hit restart.

Set parameters for the heating circuit.

Hitting "restart" again will reset the 14 day reference program and start it at day 1.

MENU 4.5 DOMESTIC HOT WATER

Auto = The Domestic Hot Water function is activated according to the schedule in menu 3.5.

On = The Domestic Hot Water function is always on.

Off = The Domestic Hot Water function is always off

90C- 1 2 3

HC (HEATING CIRCUIT) SETTINGS, MENU 5

MENU 5.1 S/W DAY = SUMMER/WINTER CHANGEOVER IN DAYTIME MODE

If this value is exceeded at outdoor sensor during the daytime mode times, the controller automatically switches the heating circuit off = Summer mode.

If the outdoor temperature drops below this value, the heating circuit is switched on again = Winter mode.

Setting range: from 0°C to 30°C / default setting: 18°C



In addition to the operating times in normal daytime operation, this setting is also valid for times with activated comfort temperature boost.

MENU 5.2 S/W NIGHT = SUMMER/WINTER CHANGEOVER IN NIGHTTIME MODE

If this value is exceeded at outdoor sensor during the nighttime mode times, the controller automatically switches the heating circuit off = Summer mode.

If the outdoor temperature drops below this value, the heating circuit is switched on again = Winter mode.

Settings range: 0°C to 30°C / Default: 12°C

MENU 5.3 CURVE = SLOPE OF THE CHARACTERISTIC HEATING CURVE

The characteristic curve is used to control the heat dissipation of the heating circuit relative to the outdoor temperature.

The demand for heat is different due to differences in the type of building/insulation/type of heating/outdoor temperature. For this reason the controller can make use of a normal straight curve (Setting simple) or a split curve (Setting split).

In the simple setting the curve can be adjusted with the help of the graphic diagram. The slope is changed, and the calculated reference flow temperature is displayed for -20 °C.

If the split mode is selected, the characteristic curve is adjusted in 3 steps. First the standard slope has to be set, after that the split point and finally the steepness of the curve after the split. While adjusting the curve the steepness of the slope and the calculated reference flow temperature for -20 °C outdoor temperature is displayed. Split curve is often selected to compensate.

Settings range:

Characteristic curve : simple or split / Default: simple

Slope : 0.0...3.0 / Default: 0.8

Splitpoint at outdoor temp.: +10°C...-10°C

Angle: differs, depends on steepness and split point

The diagram shows the influence of the selected characteristic curve steepness (standard curve) on the calculated reference flow temperature of the heating circuit. The correct curve is appointed by setting the intersection point of the calculated maximum flow temperature and the minimum outdoor temperature.

Maximum calculated flow temperature 60°C at minimum outdoor temperature according to heat demand calculation -12°C.

The intersection results in a slope of 1.2.

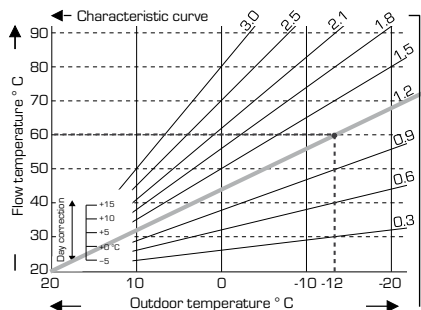

EXAMPLE 1: SIMPLE

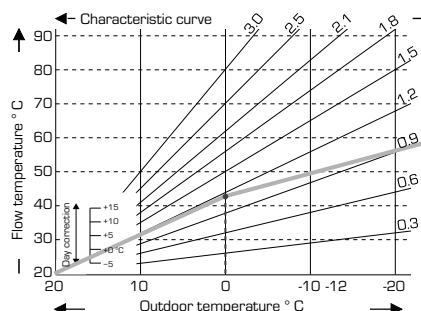

EXAMPLE 2: SPLIT

Splitpoint 0° selected with heating curve part 1 selected to 1.0 and heating curve part 2 selected to 0.8 will increase flow temp from 38° to 40° at outdoor temp 0° compared to simple heating curve 0.9

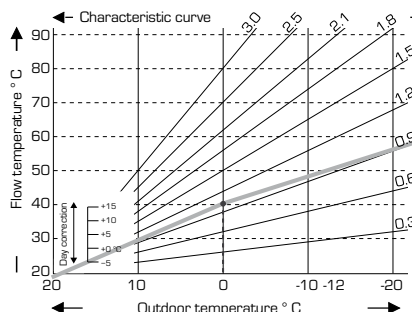

EXAMPLE 3: SPLIT

Splitpoint 0° selected with heating curve part 1 selected to 1.1 and heating curve part 2 selected to 0.7 will increase flow temp from 38° to 42° at outdoor temp 0° compared to simple heating curve 0.9

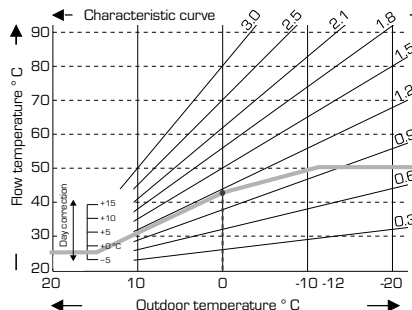

EXAMPLE 4: MAX/MIN SPLIT

Splitpoint 0° selected with heating curve part 1 selected to 1.1 and heating curve part 2 selected to 0.7 will increase flow temp from 38° to 42° at outdoor temp 0° compared to simple heating curve 0.9
Max limitation 50°C and min limitation 25°C added.



The following settings can be used for parallel translation of the characteristic for certain time periods such as daytime and nighttime mode.

MENU 5.4 DAY CORRECTION = PARALLEL TRANSLATION OF THE CHARACTERISTIC

The day correction produces a parallel translation of the heating characteristic during the daytime operating hours, since depending on the outdoor temperature it is possible that the building may not be optimally heated with the set characteristic. If the characteristic is not optimised, the following situation may occur:

in hot weather - the spaces are too cold
in cold weather - the spaces are too hot

In this case, one should gradually reduce the characteristic slope in steps of 0.2, each time raising the day correction by 2-4 °C.

This procedure can be repeated several times as needed.

Setting range: from -10°C to 50°C // Default: 5°C

MENU 5.5 NIGHT CORRECTION = PARALLEL TRANSLATION OF THE CHARACTERISTIC

The night correction produces a parallel translation of the heating characteristic during the nighttime operating hours. If a negative value is set for the night correction, the reference flow temperature is lowered accordingly during the nighttime operating hours. In this manner, primarily at night, but also during the day when no-one is at home, the room temperature is lowered, thus saving energy.

Example: A day correction of +5°C and a night correction of -2°C produces a reference flow temperature in nighttime operation that is 7°C lower.

Setting range: from -30°C to 30°C // Default: -2°C

MENU 5.6 COMFORT TEMPERATURE BOOST = PARALLEL TRANSLATION OF THE CHARACTERISTIC

The comfort temperature boost is added to the set day correction. In this manner it is possible to carry out quick heating and/or a higher temperature in the living spaces at a certain time each day.

Setting range: from 0°C to 15°C // Default: 0°C = off

MENU 5.7 REFERENCE/ACTUAL -

Permissible reference value undershoot of the heating value.

Settings range -10°C to -2 / Default: -2°C

MENU 5.8 REFERENCE/ACTUAL +

Permissible reference value overshoot of the heating value.

Settings range 2°C to 20 / Default: 2°C

90C- 2 3

HC (HEATING CIRCUIT) 2 SETTINGS, MENU 6

Menu 6 is activated when Heating circuit 2 is selected in menu 15.7.2

Note: Pump is activated when actual flow temp < target flow 2.

MENU 6.1 S/W DAY see Menu 5.1

MENU 6.2 S/W NIGHT see Menu 5.2

MENU 6.3 CURVE see Menu 5.3 including curve examples.

MENU 6.4 DAY CORRECTION see Menu 5.4

MENU 6.5 NIGHT CORRECTION see Menu 5.5

MENU 6.6 COMFORT TEMP BOOST see Menu 5.6

90C- 2 3

DHW SETTINGS, MENU 7

Menu 7 is activated when Dom. Hot water is selected in menu 15.7.2

MENU 7.1 HOT WATER MINIMUM

Minimum domestic hot water temperature outside of the operating times.

Settings range 10°C to 80 / Default: 45°C

MENU 7.2 DHW TARGET

Minimum DHW temperature during operating hours.

Settings range 10°C to 80°C / Default: 45°C

MENU 7.3 DHW TARGET HYSTERESIS

Hot water heating hysteresis during operating times.

Settings range +2°C to +20°C / Default: +10°C

90C- - - 3 ENERGY TRANSFER, MENU 8

Menu 8 is activated when Energy transfer is selected in menu 15.7.1

MENU 8.1 PUMP START TEMPERATURE

Auto = The controller uses the required flow temperature to calculate the optimal starting temp for the Energy transfer pump.

Constant = The Energy transfer pump will keep the Master Tank temperature above a fixed value. The desired temperature has to be set in menu 8.3

In both modes the Energy transfer pump will automatically stop if the Slave Tank is colder than the Master Tank.

MENU 8.2 HYSTERESIS

Master load temp hysteresis.

Settings range +2°C to +20°C / Default: +7°C

MENU 8.3 TARGET TEMPERATURE

If operating mode "Constant" is selected, (Menu 8.1), the Master load temperature has to be set here, regardless of required flow temperature.

Settings range 20°C to 90°C / Default: 70°C

90C- - - 3 SOLAR, MENU 9

Menu 9 is activated when Solar is selected in menu 15.7.1

MENU 9.1 HYSTERESIS

Solar load temp hysteresis.

Settings range pump on +3°C to +20°C / Default: +7°C

Fixed temperature pump off ΔT 2°C

MENU 9.2 PUMP STOP TEMPERATURE

Solar circulation pump stops if temperatures rise above set temperature to protect the system.

Settings range Off:60 to 150°C / Default: Off



When pump stop is activated, the temperature in the collector will be very high, thus the pressure in the system will rise and can damage your system. Pay close attention to the instructions of the system manufacturer.

90C- - - 3 LOAD PUMP, MENU 10

Menu 10 is activated when Load pump is selected in menu 15.7.1

MENU 10.1 PUMP START TEMPERATURE

The boiler flue gas temperature at which the load pump will start.

Settings range 30°C to 250°C / Default: 120°C

MENU 10.2 HYSTERESIS

Load pump temperature hysteresis.

Settings range -2°C to -40°C / Default: -20°C

MENU 10.3 MINIMUM RUNNING TIME

Minimum running time of the load pump.

Settings range 0 minutes to 30 minutes / Default: 10 minutes

90C- 1 2 3 PROTECTIONS, MENU 14

MENU 14.1 FROST PROTECTION

Frost protection function can be activated for the heat circuit. If the outdoor temperature drops below 1°C and the heat circuit is switched off, the controller switches the heat circuit back on with the reference temperature set in in menu 14.2 (min. flow temperature). As soon as the outdoor temperature exceeds 1°C the heat circuit is switched off again.

Frost protection - settings range: on, off / Default: on



Switching the frost protection function off or setting the minimum flow temperature too low can lead to severe damage of the system.

MENU 14.2 MIN. FLOW TEMPERATURE

The minimum flow temperature is the lower limit for the characteristic curve/slope and as a result of the reference flow temperature of the heat circuit.

Additionally, the min. flow temperature is the reference flow temperature for the frost protection.

Settings range: 5°C to 70°C / Default: 15°C

MENU 14.3 MAX. FLOW TEMPERATURE

This is used as the upper limit for the reference flow temperature of the heat circuit. Should the heat circuit temperature exceed this value, the heat circuit is switched off until the temperature drops below.

Settings range: 30°C to 105°C / Default: 45°C



For safety, the customer must provide an additional limiting thermostat which is connected to the pumps in series.

MENU 14.4 MAX FLOW 2

Menu 8.4 is activated when Heating circ 2 is selected in menu 15.7.2

Max. flow temperature of the Heating circ 2.

Settings range off to 105°C / Default: 45°C

MENU 14.5 ANTI-LEGIONELLA

MENU 14.5.1 AL FUNCTION

Anti-legionella function.

Settings range on/off

MENU 14.5.2 AL TSET

Target temperature for AI heating

Settings range 60°C to 99°C / Default: 70°C

MENU 14.5.3 AL INTERVAL

Interval in days between AI heatings.

Settings range 1 to 28 / Default: 7

MENU 14.5.4 AL HEAT

Shows last executed Anti-Legionella heating cycle.

90C- 1 2 3 SPECIAL FUNCTIONS, MENU 15

Sensor calibration, Remote adjuster, Mixer, etc

MENU 15.1 / 15.1.1 - 15.1.6 SENSOR CALIBRATION

Deviations in the temperature values displayed, for example due to cables which are too long or sensors which are not positioned optimally, can be compensated for manually here. The settings can be made for each individual sensor in steps of 0.5°C.



Settings are only necessary in special cases at the time of initial commissioning by the specialist. Incorrect measurement values can lead to unpredictable errors.

MENU 15.2 COMMISSIONING

Starting the commissioning help guides you in the correct order through the basic settings necessary for commissioning, and provides brief descriptions of each parameter in the display.

Pressing the "esc" key takes you back to the previous value so you can look at the selected setting again or adjust it if desired. Pressing the "esc" more than once takes you back to the selection mode, thus cancelling the commissioning help.



May only be started by a specialist during commissioning! Observe the explanations for the individual parameters in these instructions, and check whether further settings are necessary for your application.

MENU 15.3 FACTORY SETTINGS

All of the settings that have been made can be reset, thus returning the controller to its delivery state.



The entire parametrisation, statistics, etc. of the controller will be lost irrevocably. The controller must then be commissioned once again.

MENU 15.4 EXPANSIONS

This menu can only be selected and used if additional options or expansion modules have been built into the controller.

The associated supplementary installation, mounting and operation instructions are then included with the specific expansion.

MENU 15.5 MIXER



Settings are only necessary at the time of initial commissioning by the specialist. Incorrect measurement values can lead to severe unpredictable errors.

MENU 15.5.1 VALVE TYPE

Mixer valve operation range could be altered. 90/180/270° example valve 5MG needs 270°.

MENU 15.5.2 MIN. ANGLE

Minimum opening angle of the mixer valve

Settings range: 0 to 20 default 0%

MENU 15.5.3 MAX. ANGLE

Maximum opening angle of the mixer valve.

Settings range: 80 to 100 default: 100%

MENU 15.5.4 DIRECTION

Opening of valve CCW - counter clock wise. CW - clock wise.

MENU 15.5.5 TURN TIME

The mixer is switched on i.e. is opening or closing for the timespan set here, then the temperature is measured to control the flow temperature.

Settings range: 1.0 sec to 3 sec. / Default: 2 sec.

MENU 15.5.6 PAUSE FACTOR

The calculated pause time of the mixer is multiplied with the value set here. If the pause factor is "1", the normal pause time is used, "0.5" will use half the normal pause time, "4" would quadruple the pause time.

Settings range: 0.1 to 4.0 / Default: 1.0

MENU 15.5.7 INCREASE

If the temperature changes very fast, this value is added to the influence of fast flow temperature rise on mixer reaction.

Influence of mixer reaction is updated once every minute.

Settings range: 0 to 20 / Default: 0

MENU 15.5.8 CALIBRATION

Full calibration of valve positions.

MENU 15.6 ROOM SENSOR

The settings necessary for the optional room sensor CRS231 are made in this menu.

The 3 modes "continuous day", "continuous night" and "Time controlled/automatic" can be switched at the CRS231.

Additionally the reference temperature of the flow can be parallel translated by turning the control wheel. If the wheel is set to minimum, only the min values that can be set in the protective functions menu will be used.



In the operating modes "Reference value" and 14day ref." the remote adjuster is without function.

MENU 15.6.1 ROOM SENSOR

This value is used to appoint the amount of influence in percent the room temperature has on the reference flow temperature. For every degree of deviation of the room temperature from the reference room temperature the percentage of the calculated reference flow temperature set here is added to or, respectively, subtracted from the reference flow temperature. As long as it is within the limits of the min. and max. flow temperatures that can be set in the protective functions.

Example: Reference roomtemp.: e.g. 25 °C: room temp.: e.g. 20 °C = 5 °C deviation.
 Calculated reference temp.: e.g. 40 °C: room sensor: 10 % = 4 °C.

5 X 4 °C = 20 °C According to this 20 °C are added to the reference flow temperature, resulting in 60 °C. If the value is higher than the one set in max. flow temp., the resulting temperature is only the one set in max. flow temp.

Settings range: 0 % to 20 % / Default: 0 %

MENU 15.6.2 ROOM REFERENCE DAY

The desired room temperature for day mode. As long as this temperature is not reached, the reference flow temperature is raised or respectively lowered according to the percent setting in "room sensor". If "room sensor" is set to 0%, this function is deactivated.

Settings range: 10 °C to 30 °C / Default: 20 °C

MENU 15.6.3 ROOM REFERENCE NIGHT

The desired room temperature for night mode. As long as this temperature is not reached, the reference flow temperature is raised or respectively lowered according to the percent setting in "room sensor". If "room sensor" is set to 0%, this function is deactivated.

Settings range: 10 °C to 30 °C / Default: 20 °C

MENU 15.7 SYSTEM

Selection of system functions.

MENU 15.7.1 EXTRA FUNCTION 1.

Additional function with selectable variants:

See chapter Hydronic variants, page. 10.

90C- 1 - - Circulation pump / Valve position / Off

90C- - 2 - Temperature / Valve position / Off

90C- - - 3 Temperature / Valve position / Energy transfer / Solar / Load pump / Off

MENU 15.7.2 EXTRA FUNCTION 2

Additional function with selectable variants:

See chapter Hydronic variants, page. 10.

90C- 1 - - Not available

90C- - 2 - Heating circulation 2 / Domestic hot water / Off

90C- - - 3 Heating circulation 2 / Domestic hot water / Off

MENU 15.7.3 VALVE POSITION

When Extra function 1 with option Valve position is activated in menu 15.7.1 this menu is unlocked. Valve position for activation of auxiliary heat. Position 50% is default and is recommended when VRB140 or BIV valves are used.

Setting range: from 20 to 100% default: 50%.

MENU 15.7.4 HEAT DELAY

When Extra function 1 with option Valve position is activated in menu 15.7.1 this menu is unlocked. Time delay before activation of aux. heat.

Setting range: from 0 to 120 min, default 60 min.

Time counter is reset when valve position is less than specified position.

MENU 15.7.5 VALVE DELAY

When Extra function 1 with option Valve position is activated in menu 15.7.1 this menu is unlocked. Time delay before valve start to move.

Setting range: from 0 to 120 min, default 70 min.

Time counter is reset when valve position is less than specified position.

90C- 1 2 3 MENU LOCK, MENU 16

Menu lock can be used to secure the controller against unintentional changing and compromise of basic functions.

The menus listed below remain completely accessible despite the menu lock being activated, and can be used to make adjustments if necessary:

1. Measurement
2. Statistics
3. Times
16. Menu lock
17. Service data

MENU 16.1 MENU LOCK INFO

To block the other menus, select "Menu lock on".
 To enable the menus again, select "Menu lock off".

Setting range: on, off / default setting: off

90C- 1 2 3 SERVICE DATA, MENU 17

17.1	90C 2011/04/09 4436
17.2 outdoor	0°C
17.3 Flow	0°C

Service data" can be used for remote diagnosis by a specialist or the manufacturer in the event of an error, etc.



Enter the values at the time when the error occurs into the table.



17.1		17.25		17.50
17.2		17.26		17.51
17.3		17.27		17.52
17.4		17.28		17.53
17.5		17.29		17.54
17.6		17.30		17.55
17.7		17.31		17.56
17.8		17.32		17.57
17.9		17.33		17.59
17.10		17.34		17.60
17.11		17.35		17.61
17.12		17.36		17.62
17.13		17.37		17.63
17.14		17.38		17.64
17.15		17.40		17.65
17.16		17.41		17.66
17.17		17.42		17.67
17.18		17.43		17.68
17.19		17.44		17.69
17.20		17.45		17.70
17.21		17.46		17.71
17.22		17.47		17.72
17.23		17.48		17.73
17.24		17.49		17.74

Subject to technical modifications and amendments. The illustrations and description are not exhaustive.

90C- 1 2 3 LANGUAGE, MENU 18

Selection of the menu language.

Menu 18.1 Deutsch

Menu 18.10 Polski

Menu 18.2 English

Menu 18.11 Suomi

Menu 18.3 Français

Menu 18.12 Eesti keel

Menu 18.4 Svenska

Menu 18.13 Română

Menu 18.5 Italiano

Menu 18.14 Lietuvių

Menu 18.6 Türkçe

Menu 18.15 Čeština

Menu 18.7 Русский

Menu 18.16 Ελληνικά

Menu 18.8 Español

Menu 18.17 Dansk

Menu 18.9 Norsk

ROOM SENSOR

FOR EASY REMOTE ADJUSTER OF SENSOR FUNCTIONS.

Automatic mode is selected when switch is put on:



Night mode is selected when switch is put on:



Day mode is selected when switch is put on:



Adjust settings in menu 15.6.1 "influence of the room temp on the target flow"

FOR "VACATION" PROGRAM PUT KNOB ON:



Possible only when frostprotection is activated in Menu 14.1

Heating circuit will run on min. flow temp when outdoor temp is lower than 1°C **or** when indoor temp is lower than +10°C. Min flow temp settings, see menu 14.2

Heating circuit will be shut off when outdoor temp is higher than 0°C **and** indoor temp is higher than +10°C

Turning the knob will influence room temperature reference value.



INSTALLATION

Temperature sensor

Remote control +/- blue
 Sensor yellow
 Sensor earth white

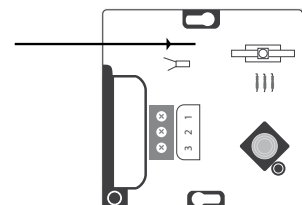

HYDRONIC VARIANTS

Note! All application examples are overall idea sketches, and do not claim to be complete. Always also take locally laws and regulations into consideration.

The controller does not replace safety devices under any circumstances.

Depending on the specific application, additional system components and safety components may be mandatory, such as check valves, non-return valves, safety temperature limiters, scalding protectors, etc., and must therefore be provided.

APPL.	AVAILABLE FOR VERSION	FUNCTION 90C	ELECTRICAL CONNECTION	SETTING
1	90C- 1 2 3	PUMP CONTROL HEAT CIRCUIT 1	Connect pump heat circ1 as P1	Menu 15.7.1 Select: Circulation pump
		AUXILIARY HEAT CONTROL Activated by mixer position.	Connect aux heat as P1 (90C-1) Connect aux heat as P3 (90C-2,90C-3)	Menu 15.7.1 Settings in menu 15.7.3 – 15.7.5 Select: Position
3	90C- – 2 3	PUMPCONTR. HEAT CIRCUIT 1	Connect pump heat circ1 as P1	
		AUXILIARY HEAT CONTROL Activated by mixer position	Connect aux heat as P3	Menu 15.7.1 Settings in menu 15.7.3 – 15.7.5 Select: Position
4	90C- – 2 3	PUMPCONTR. HEAT CIRCUIT 1	Connect pump heat circ1 as P1	
		PUMPCONTR. HEAT CIRCUIT 2 Activated when temperature at sensor 3 is lower than specified in menu 6.	Connect pump heat circ 2 as P2 Connect sensor as sensor 3 in sensor box 2	Menu 15.7.2 Settings in menu 6.1-6.6 Select: Heating circ 2
5	90C- – 2 3	PUMPCONTR. HEAT CIRCUIT 1	Connect pump heat circ1 as P1	
		AUXILIARY HEAT CONTROL Activated by mixer position	Connect aux heat as P3	Menu 15.7.1 Settings in menu 15.7.3 – 15.7.5 Select: Position
		PUMPCONTR. HEAT CIRCUIT 2 Activated when temperature at sensor 3 is lower than specified in menu 6.	Connect pump heat circ 2 as P2 Connect sensor as sensor 3 in sensor box 2	Menu 15.7.2 Settings in menu 6.1-6.6 Select: Heating circ 2
6	90C- – 2 3	PUMP CONTROL HEAT CIRCUIT 1	Connect pump heat circ1 as P1	
		PUMPCONTR. HEAT CIRCUIT 2 Activated when temperature at sensor 3 is lower than specified in menu 6.	Connect pump heat circ 2 as P2	Menu 15.7.2 Settings in menu 6.1-6.6 Select: Heating circ 2
		HEAT SOURCE TEMPERATURE CONTROL With heat circuit as reference temp.	Connect boiler as P3	Menu 15.7.1 Settings in menu 5.7-5.8 Select: Temperature
			Connect sensor as sensor 3+4 in sensor box 2	

APPL.	AVAILABLE FOR VERSION	FUNCTION 90C	ELECTRICAL CONNECTION	SETTING
7	90C- - 2 3	PUMP CONTROL HEAT CIRCUIT 1	Connect pump heat circ1 as P1	
		DOMESTIC HOT WATER (DHW)	Connect DHW pump as P2	Menu 15.7.2 Settings in menu 7.1-7.3 Select: Dom. Hot water
		HEAT SOURCE TEMPERATURE CONTROL With heat circuit as reference temp.	Connect boiler as P3 Connect sensor as sensor 3+4 in sensor box 2	Menu 15.7.1 Settings in menu 5.7-5.8 Select: Temperature
8	90C- - 2 3	PUMP CONTROL HEAT CIRCUIT 1	Connect pump heat circ1 as P1	
		PUMPCONTR. HEAT CIRCUIT 2 Activated when temperature at sensor 3 is lower than specified in menu 6.	Connect pump heat circ 2 as P2	Menu 15.7.2 Settings in menu 6.1-6.6 Select: Heating circ 2
		HEAT SOURCE TEMPERATURE CONTROL By temperature with heat circuit 1 as reference	Connect heat source as P3	Menu 15.7.1 Settings in menu 5.7-5.8 Select: Temperature
9	90C- - 2 3	PUMP CONTROL HEAT CIRCUIT 1	Connect sensor as sensor 3+4 in sensor box 2 Connect pump heat circ1 as P1	
		PUMPCONTR. HEAT CIRCUIT 2 Activated when temperature at sensor 3 is lower than specified in menu 6.	Connect pump heat circ 2 as P2	Menu 15.7.2 Settings in menu 6.1-6.6 Select: Heating circ 2
		HEAT SOURCE TEMPERATURE CONTROL By temperature with heat circuit 1 as reference	Connect heat source as P3	Menu 15.7.1 Settings in menu 5.7-5.8 Select: Temperature
10	90C- - 2 3	PUMP CONTROL HEAT CIRCUIT 1	Connect pump heat circ1 as P1	
		HEAT PUMP CONTROL (Primary heat source) By floating temperature with heat circuit 1 as reference	Connect Heat Pump as P3	Menu 15.7.1 Settings in menu 5.7-5.8 Select: Temperature
		AUX. HEAT SOURCE CONTROL By temperature control	Connect Aux.heat source as P2	Menu 15.7.2 Settings in menu 7.1-7.3 Select: Dom. Hot Water
11	90C- - 2 3	PUMP CONTROL HEAT CIRCUIT 1	Connect pump heat circ1 as P1	
		DOM HOT WATER CONTROL By temperature control	Connect diverting valve as P2	Menu 15.7.2 Settings in menu 6.1-6.6 Select: Heating circ 2
		HEAT SOURCE TEMPERATURE CONTROL By floating temperature	Connect heat source as P3	Menu 15.7.1 Settings in menu 5.7-5.8 Select: Temperature
			Connect sensor as sensor 3+4 in sensor box 2	

APPL.	AVAILABLE FOR VERSION	FUNCTION 90C	ELECTRICAL CONNECTION	SETTING
12	90C- - - 3	PUMP CONTROL HEAT CIRCUIT 1	Connect pump heat circ1 as P1	
		HEAT PUMP CONTROL (Primary heat source) By floating temperature	Connect Heat Pump as P3	Menu 15.7.2 Settings in menu 6.1-6.6 Select: Heating circ 2
		AUX. HEAT SOURCE CONTROL By valve position	Connect Aux.heat source as P2	Menu 15.7.1 Settings in menu 15.7.3 - 15.7.5 Select: Position
			Connect sensor as sensor 3 in sensor box 2	
13	90C- - - 3	PUMP CONTROL HEAT CIRCUIT 1	Connect pump heat circ1 as P1	
		DOM HOT WATER CONTROL By temperature control	Connect heat source as P2	Menu 15.7.2 Settings in menu 7.1-7.3 Select: Dom.Hot Water
		ENERGY TRANSFER CONTROL	Connect tank circ pump as P3	Menu 15.7.1 Settings in menu 8.1-8.3 Select: Energy transfer
			Connect sensor as sensor 3+4+7 in sensor box 2	
14	90C- - - 3	PUMP CONTROL HEAT CIRCUIT 1	Connect pump heat circ1 as P1	
		PUMPCONTR. HEAT CIRCUIT 2 By floating temperature	Connect heat source as P2	Menu 15.7.2 Settings in menu 6.1-6.6 Select: Heating circ 2
		ENERGY TRANSFER CONTROL	Connect tank circ pump as P3	Menu 15.7.1 Settings in menu 8.1-8.3 Select: Energy transfer
			Connect sensor as sensor 3+4+7 in sensor box 2 <i>Note: Heat circuit 2 must have a lower curve than Heat circuit 1</i>	
15	90C- - - 3	PUMP CONTROL HEAT CIRCUIT 1	Connect pump heat circ1 as P1	
		SOLAR PUMP CONTROL By floating temperature	Connect solar circ pump as P3	Menu 15.7.1 Settings in menu 9.1 Select: Solar
		PUMP CONTROL HEAT CIRCUIT 2 By floating temperature	Connect circulation pump as P2	Menu 15.7.2 Settings in menu 6.1-6.6 Select: Heating circ 2
			Connect sensor as sensor 3+4+7 in sensor box 2 <i>Note: Heat circuit 2 must have the same curve as Heat circuit 1</i>	
16	90C- - - 3	PUMP CONTROL HEAT CIRCUIT 1	Connect pump heat circ1 as P1	
		PUMP SOLAR CONTROL By floating temperature	Connect solar circ pump as P3	Menu 15.7.1 Settings in menu 9.1 Select: Solar
		DOM HOT WATER CONTROL By temperature control	Connect heat source as P2	Menu 15.7.2 Settings in menu 7.1-7.3 Select: Dom. Hot Water
			Connect sensor as sensor 3+4+7 in sensor box 2	
17	90C- - - 3	PUMP CONTROL HEAT CIRCUIT 1	Connect pump heat circ1 as P1	
		DOM HOT WATER CONTROL By temperature control	Connect tank circ pump as P2	Menu 15.7.2 Settings in menu 7.1-7.3 Select: Dom.Hot Water
		HEAT SOURCE TEMPERATURE CONTROL By valve position	Connect heat source as P3	Menu 15.7.1 Settings in menu 15.7.3 - 15.7.5 Select: Position
			Connect sensor as sensor 3 in sensor box 2 <i>Recommended setting: 15.7.3: 75% 15.7.4: 20 min 15.7.5: 0 min</i>	
18	90C- - - 3	PUMP CONTROL HEAT CIRCUIT 1	Connect pump heat circ1 as P1	
		LOADING PUMP CONTROL By flue gas temperature controll	Connect loading pump as P3	Menu 15.7.1 Settings in menu 10.1-10.2 Select: Load pump
		DOM HOT WATER CONTROL By temperature control	Connect heat source as P2	Menu 15.7.2 Settings in menu 7.1-7.3 Select: Dom. Hot Water
			Connect sensor as sensor 3+7 in sensor box 2. <i>Note: Sensor S7 must be replaced with sensor CRS215 to be able to handled higher flue gas temperature</i>	

Notes in application examples:
P1 = Output 1 - Pumpcontrol, P2 = Output 2 - Extra function 2, P3 = Output 3 - Extra function 1
S3 = Sensor 3, S4 = Sensor 4, S7 = Sensor 7
1* = Sensor box 1, 2* = Sensor box 2

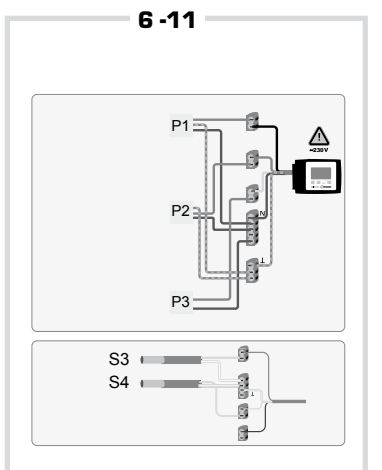
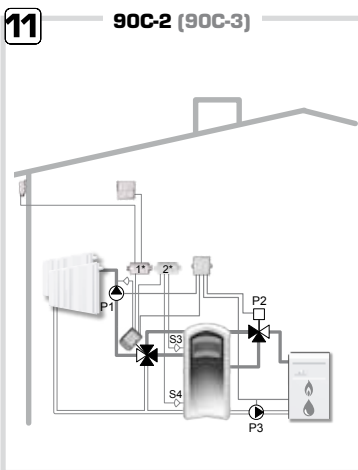
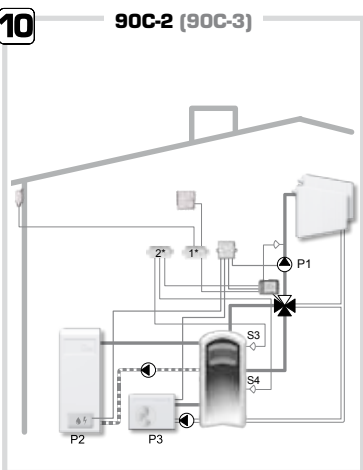
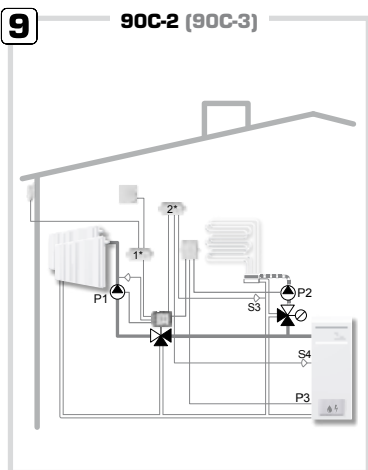
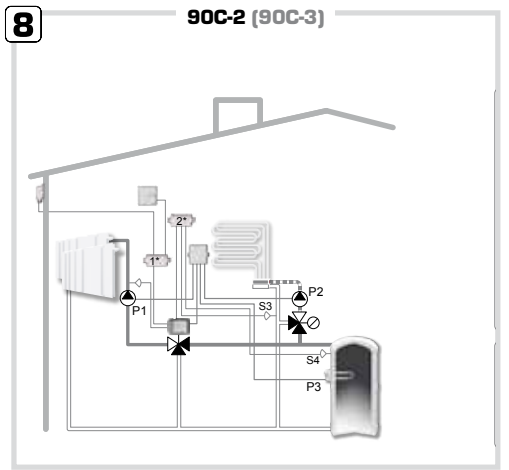
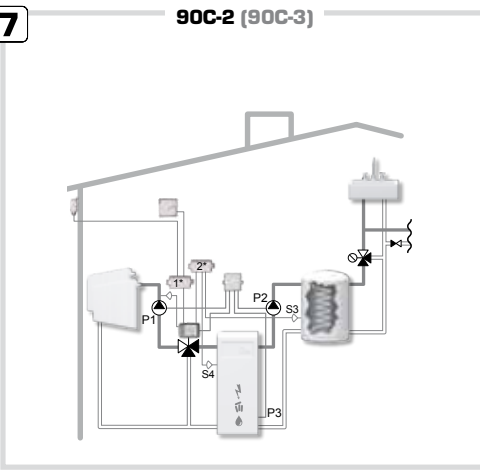
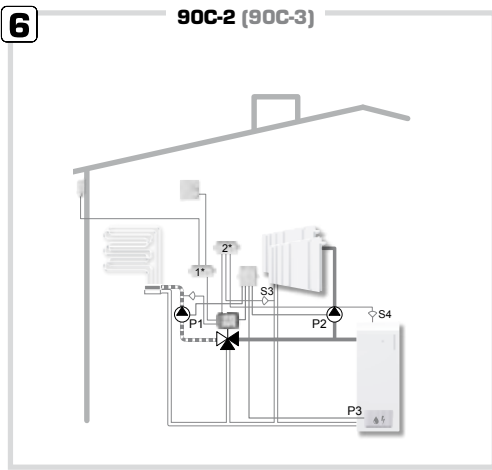
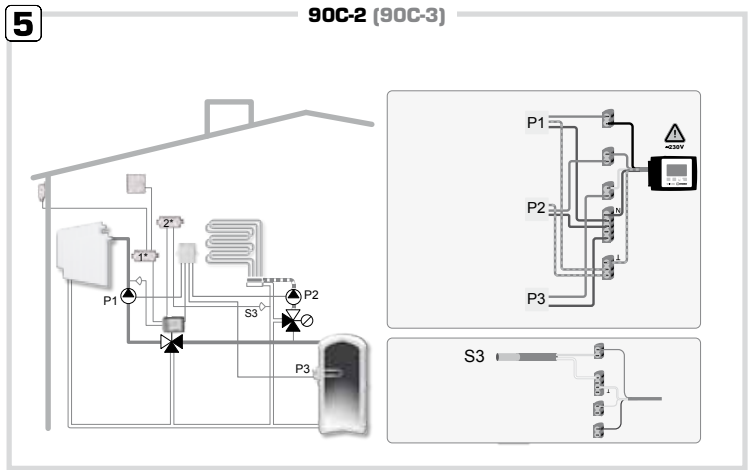
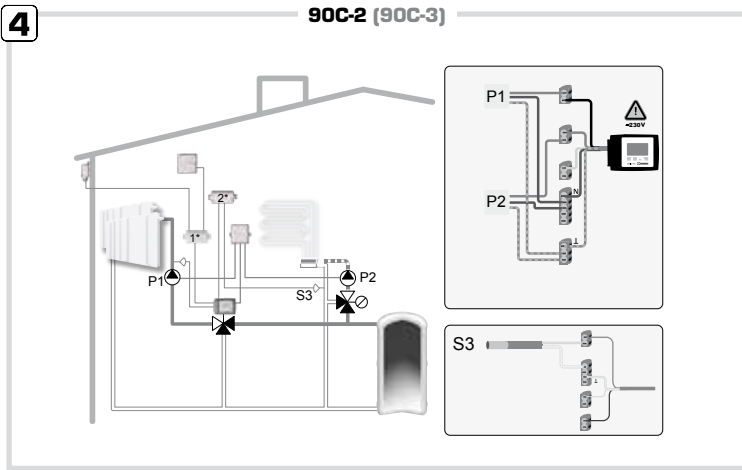
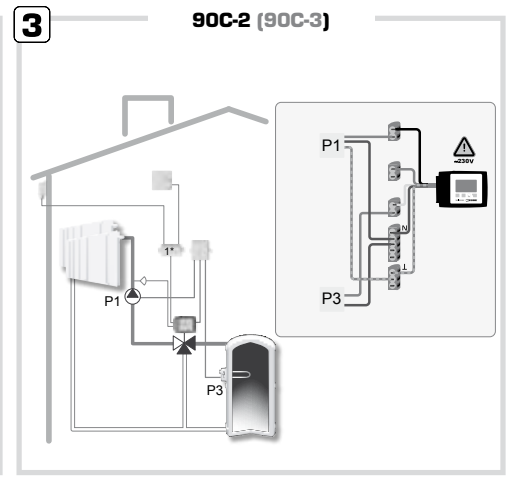
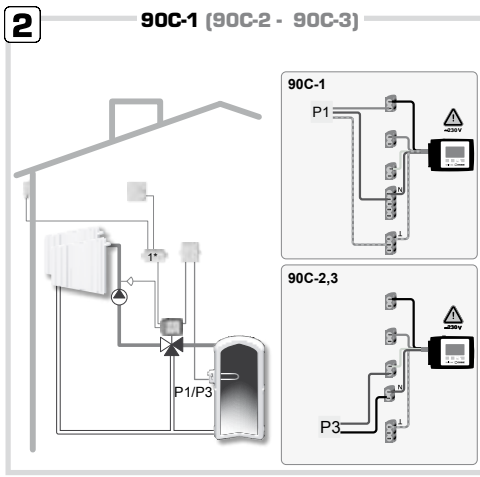
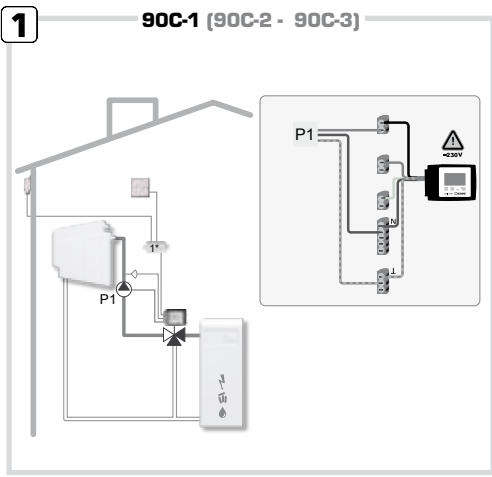

12

90C-3

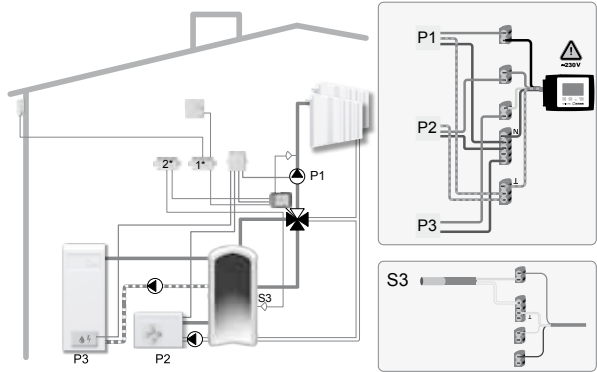

13

90C-3

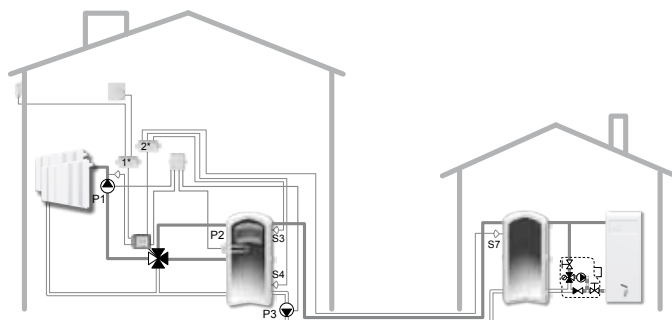

14

90C-3

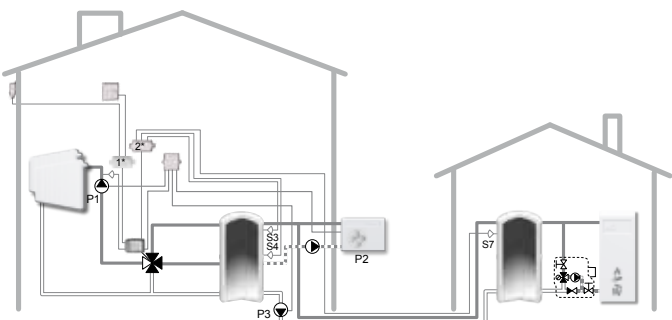

13 - 14

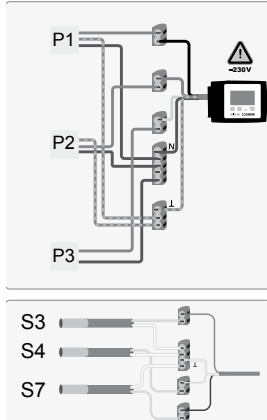

15

90C-3

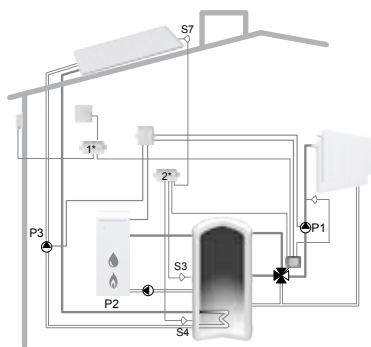

16

90C-3

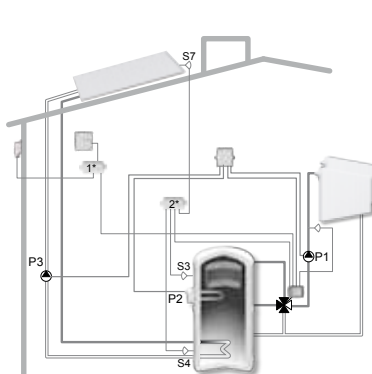

15-16

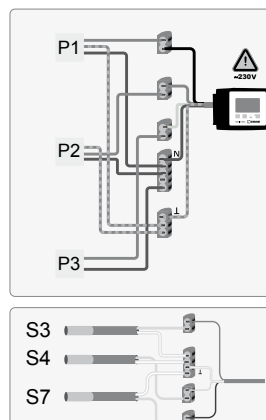

17

90C-3

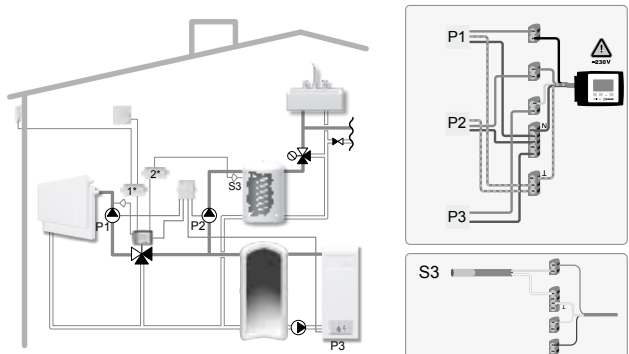

18

90C-3

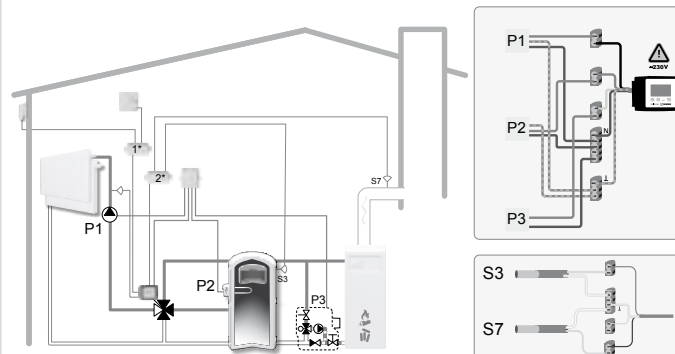



NO.1 IN HYDRONIC SYSTEM CONTROL